

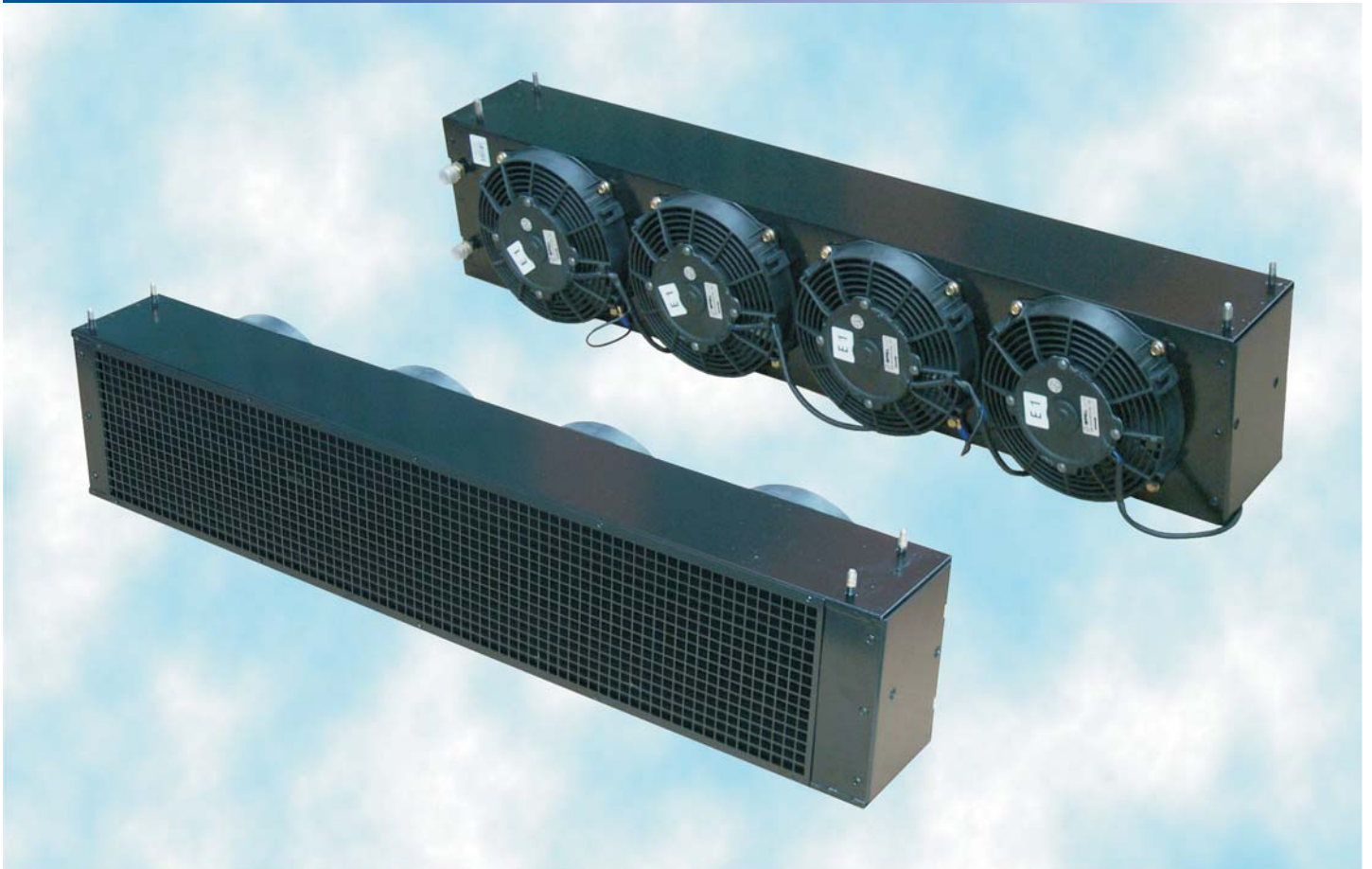

AUTOCLIMA
QUALITY & COMFORT

CONDENSATORE

K 65





DENVER
AIR CONDITIONERS



 Condensatore elettroventilato adatto al montaggio sotto pavimento o a tetto sotto opportuna carenatura (non inclusa nella fornitura).

 Condenseur electroventilé pour montage sous chassis ou sur le toit, sous un propre carénage (non inclu).

 Electroventilated condenser for underfloor installation or for roof top mounting (under appropriate cover, not included).

 Kondensator mit Elektrolüfter für Unterflurmontage. Kondensator mit Elektrolüfter für Unterflur- oder Dachmontage, unter eine geeignete Deckung (nicht inbegriffen).

 Condensador electroventilado apto al montaje bajo chasis o bien a techo abajo de oportuna cobertura (non incluida).

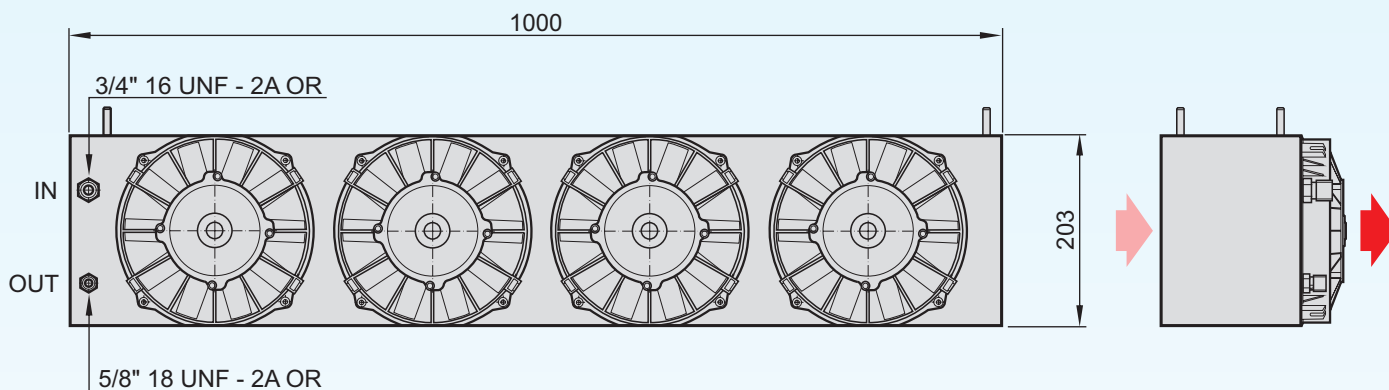
CONDENSATORE K 65**12V cod.30301009/2****CONDENSATORE K 65****24V cod.30301164**

Dati tecnici nominali	Données techniques nominaux	Nominal technical data	Technische Nominal-Eigenheiten	Datos técnicos	K 65
• Potenza max. evaporatore abbinabile	• Puissance frigorifique évaporateur correspondant	• Cooling capacity of matching evaporator	• Kälteleistung entspr. verdampfer	• Potencia frigorífica del evaporador correspondiente	8,5 kW
• Tensione alimentazione	• Tension d'alimentation	• Working voltage	• Spannung	• Tension de alimentación	12V c.c / 24V c.c
• Assorbimento elettrico	• Absorption électrique	• Power consumption	• Stromverbrauch	• Intensidad absorbida	22A (12V) / 11A (24V)
• Portata aria	• Débit air	• Air flow	• Gebläseleistung	• Caudal de aire	1900 m³/h
• Peso	• Poids	• Weight	• Gewicht	• Peso	17 Kg

La nostra società si riserva il diritto di migliorare e modificare ciascuno dei modelli illustrati, senza alcun preavviso.
 Notre Société se réserve le droit d'améliorer et de modifier sans aucun préavis chacun des modèles ci-illustrés.

The company reserves the right to modify any design in the model without prior notice as per our policy of continuous improvement of design, quality and performance.

Unsere Firma behält sich das Recht vor, jeden Modell hier erläutert ohne Vorankündigung zu ändern und verbessern.

La compañía se reserva el derecho a modificar cualquier diseño en los modelos sin previo aviso debido a la política de continua mejora en el diseño, en la calidad y en el rendimiento



Autoclima S.p.A. - 10020 Cambiano (TO) - ITALY
 Via Cavalieri di Vittorio Veneto, 15 - Tel. 011.94.43.210 - Fax 011.94.43.230
 Internet: <http://www.autoclima.com> e-mail: sales@autoclima.com

STAMPATO IN ITALIA - RIPRODUZIONE VIETATA

Cod.80819168