



 Evaporatore universale adatto per l'installazione orizzontale in un vano del veicolo. E' dotato di 2 bocchette orientabili per la mandata dell'aria.

 Evaporateur très compact pour application universelle en montage horizontal. Les deux grilles de diffusion d'air sont orientables.

 Horizontally mounted, it is a compact and versatile evaporator for universal installations. The louvers for air distribution are swinging.

 Universalverdampfer geeignet für den waagerechten Einbau in einem Raum des Fahrzeuges. Es besteht aus 2 regelbare Düsen für die Lufteinführung.

 Evaporador universal idoneo a la instalacion horizontal en un ambiente del vehiculo. Es suministrado con 2 difusores orientables por el envio de l'aire.

EVAPORATORE E 33

12V cod.20201340



EVAPORATORE E 33

24V cod.20201341

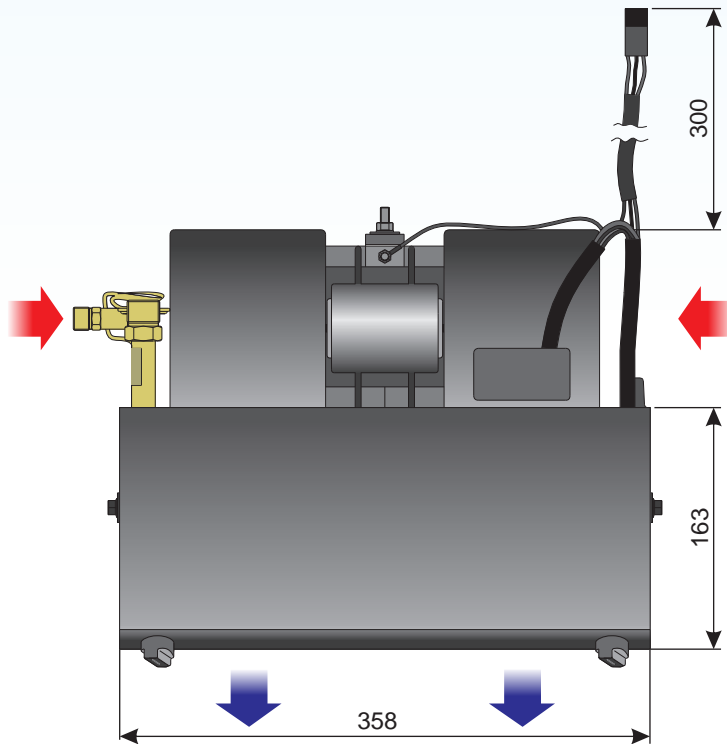
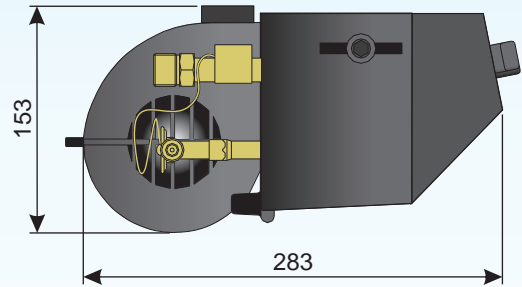
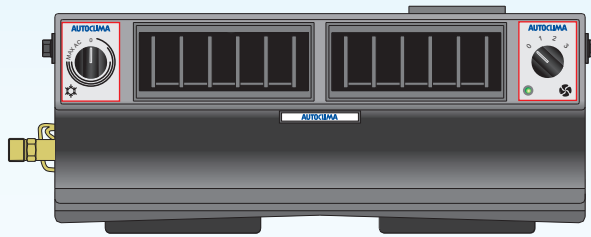

Dati tecnici nominali	Données techniques nominaux	Nominal technical data	Technische Nominal-Eigenheiten	Datos técnicos	E 33
<ul style="list-style-type: none"> <li>• Potenza frigorifera</li> <li>• Tensione alimentazione</li> <li>• Assorbimento elettrico</li> <li>• Portata aria</li> <li>• Refrigerante</li> <li>• Peso</li> </ul>	<ul style="list-style-type: none"> <li>• Puissance frigorifique</li> <li>• Tension d'alimentation</li> <li>• Absorption électrique</li> <li>• Débit air</li> <li>• Réfrigérant</li> <li>• Poids</li> </ul>	<ul style="list-style-type: none"> <li>• Cooling capacity</li> <li>• Working voltage</li> <li>• Power consumption</li> <li>• Air flow</li> <li>• Coolant</li> <li>• Weight</li> </ul>	<ul style="list-style-type: none"> <li>• Kälteleistung</li> <li>• Spannung</li> <li>• Stromverbrauch</li> <li>• Gebläseleistung</li> <li>• Kühlmittel</li> <li>• Gewicht</li> </ul>	<ul style="list-style-type: none"> <li>• Potencia frigorífica</li> <li>• Tension de alimentación</li> <li>• Intensidad absorbida</li> <li>• Caudal de aire</li> <li>• Refrigerador</li> <li>• Peso</li> </ul>	<ul style="list-style-type: none"> <li>• 3,3 kW</li> <li>• 12Vc.c / 24Vc.c</li> <li>• 8,5A (12V) / 4,2A (24V)</li> <li>• 320 m<sup>3</sup>/h</li> <li>• R134a</li> <li>• 3,7 Kg</li> </ul>

La nostra società si riserva il diritto di migliorare e modificare ciascuno dei modelli illustrati, senza alcun preavviso.

Notre Société se réserve le droit d'améliorer et de modifier sans aucun préavis chacun des modèles ci-illustrés.

The company reserves the right to modify any design in the model without prior notice as per our policy of continuous improvement of design, quality and performance.

Unsere Firma behält sich das Recht vor, jeden Modell hier erläutert ohne Vorankündigung zu ändern und verbessern.

La compañía se reserva el derecho a modificar cualquier diseño en los modelos sin previo aviso debido a la política de continua mejora en el diseño, en la calidad y en el rendimiento



Autoclima S.p.A. - 10020 Cambiano (TO) - ITALY  
 Via Cavalieri di Vittorio Veneto, 15 - Tel. 011.94.43.210 - Fax 011.94.43.230  
 Internet: <http://www.autoclima.com> e-mail: [sales@autoclima.com](mailto:sales@autoclima.com)

STAMPATO IN ITALIA - RIPRODUZIONE VIETATA

Cod.80819136